

5056

400

20141012

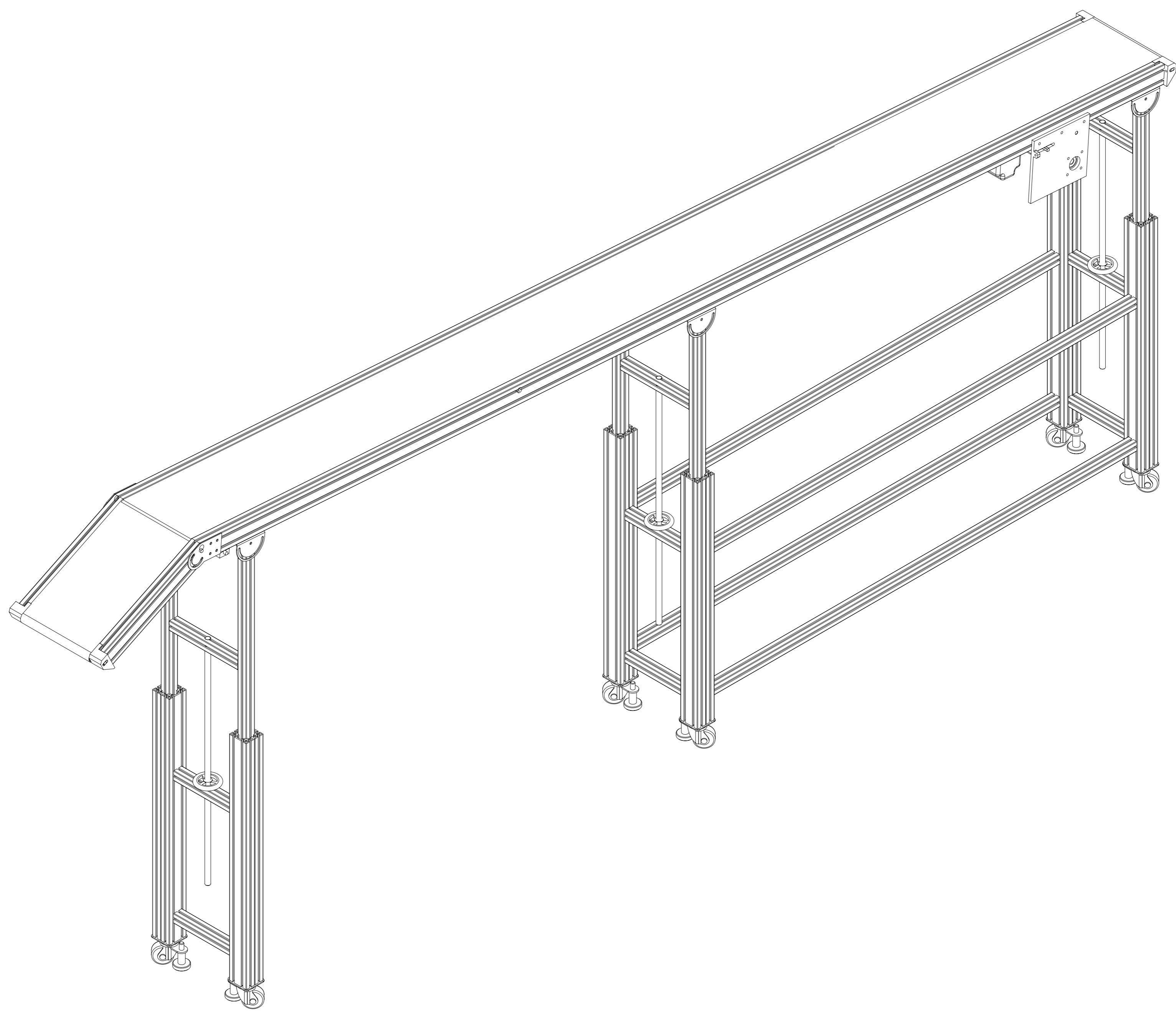

20141012